

KERN[®] **KERN & Sohn GmbH**

Ziegelei 1
D-72336 Balingen
E-Mail: info@kern-sohn.com

Phone: +49-[0]7433- 9933-0
Fax: +49-[0]7433-9933-149
Internet: www.kern-sohn.com

Operating manual Precision balances

KERN EWJ

Version 1.2
08/2014
GB



EWJ-BA-e-1412



KERN EWJ

Version 1.2 08/2014

Operating manual Precision balance

Contents

1	Technical data	4
2	Appliance overview	6
2.1	Keyboard overview	8
2.2	Overview of display	9
3	Basic Information (General)	10
3.1	Proper use	10
3.2	Improper Use	10
3.3	Warranty	10
3.4	Monitoring of Test Resources.....	11
4	Basic Safety Precautions	11
4.1	Pay attention to the instructions in the Operation Manual.....	11
4.2	Personnel training.....	11
5	Transport and storage	11
5.1	Testing upon acceptance	11
5.2	Packaging / return transport	11
6	Unpacking, Setup and Commissioning	12
6.1	Installation Site, Location of Use	12
6.2	Unpacking, Scope of delivery	12
6.2.1	Scope of delivery / serial accessories:	12
6.2.2	Installing / removing transport fittings.....	13
6.3	Mains connection.....	13
6.4	Storage battery operation (optional)	14
6.5	Connection of peripheral devices	14
6.6	Initial Commissioning.....	14
6.7	Adjustment.....	15
6.7.1	Manual internal adjustment by pressing button.....	15
6.7.2	Automatic internal adjustment	16
6.8	Verification	17
7	Operation	18
7.1	Start-up	18
7.2	Switching Off	18
7.3	Zeroing.....	18
7.6	Percent determination	19
7.7	Parts counting.....	20
7.8	Manual totalizing.....	21
7.9	Automatic adding-up.....	24

8	Menu	26
8.1	Navigation in the menu.....	26
8.2	Access to technology menu.....	27
8.3	Overview.....	28
9	Interfaces.....	31
9.1	Technical data	31
9.2	Printer operation (RS 232).....	32
9.3	Output log (continuous output)	33
10	Servicing, maintenance, disposal	33
10.1	Clean	33
10.2	Servicing, maintenance	33
10.3	Disposal.....	33
11	Instant help.....	34
12	Declaration of conformity	35

1 Technical data

KERN	EWJ 300-3	EWJ 300-3H	EWJ 3000-2
Readability (d)	0.001 g	0.001 g	0.01 g
Weighing range (max)	300 g	300 g	3000 g
Reproducibility	0.001g	0.001g	0.02 g
Linearity	±0.003 g	±0.003 g	±0.05 g
Smallest part weight for piece counting	2 mg	2 mg	20 mg
Reference quantities at piece counting	10, 20, 50, 100, 200		
Weighing Units	g, ct, dwt, lb, mo, oz, ozt, tl (HK), tl (Singap., Malays), tl (Tw)		
Adjustment	internal		
Warm-up time	2 hours		
Stabilization time (typical)	3 sec.		
Operating temperature	+ 5° C + 40° C		
Humidity of air	max. 80 % (not condensing)		
Dimensions, completely assembled (wind shield) (W x D x H) mm	220 x 315 x 180	220 x 315 x 321	220 x 315 x 180
Dimensions of the housing (B x D x H) mm	220 x 315 x 95		
Dimensions of windshield inside (B x D x H) mm	145 x 160 x 80	155 x 175 x 217	-
Dimensions of windshield outside (B x D x H) mm	158 x 143 x 82	180 x 191 x 230	-
Weighing plate, stainless steel (mm)	Ø 80		Ø 135
Weight kg (net)	2200 g	2560 g	2900 g
Input voltage balance	12 V / 2500 mA		
Rechargeable battery (optional)	Service life – background illumination ON 10 h		
	Operating time – background illumination OFF 15		
	Loading time 4h		
Interfaces	RS-232		
	USB		

KERN	EWJ 600-2M	EWJ 6000-1M
Readability (d)	0.01 g	0.1 g
Weighing range (max)	600 g	6000 g
Reproducibility	0.01 g	0.1 g
Linearity	± 0,03 g	± 0.3 g
Verification value (e)	100 mg	1 g
Verification class	II	II
Minimum weight (min)	500 mg	5 g
Smallest part weight for piece counting	20 mg	20 mg
Reference quantities at piece counting	10, 20, 50, 100, 200	
Weighing unit	g	g
Adjustment	internal	
Warm-up time	2 hours	2 hours
Stabilization time (typical)	3 sec.	
Operating temperature	+ 5° C + 40° C	
Humidity of air	max. 80 % (not condensing)	
Dimensions fully mounted (wind shield) (W x D x H) mm	220 x 315 x 180	-
Dimensions of the housing (B x D x H) (mm)	220 x 315 x 95	
Dimensions of windshield inside (B x D x H) mm	145 x 160 x 80	-
Dimensions of windshield outside (B x D x H) mm	158 x 143 x 82	-
Weighing plate, stainless steel (mm)	Ø 135	155 x 145
Weight kg (net)	2560 g	2900 g
Input voltage balance	12 V / 2500 mA	
Rechargeable battery (optional)	Service life – background illumination ON 10 h	
	Operating time – background illumination OFF 15	
	Loading time 4h	
Interfaces	RS-232	
	USB	

2 Appliance overview

Example EWJ 300-3 / EWJ 600-2M:

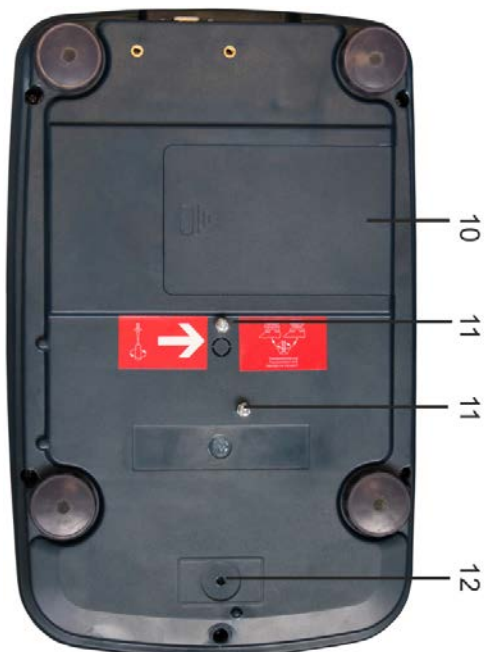
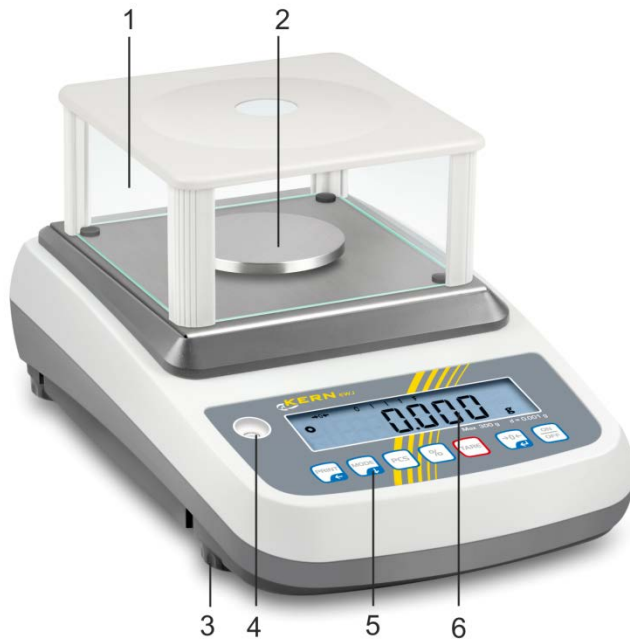

1. Windshield
2. Weighing pan
3. Levelling screw
4. Bubble level
5. Keyboard
6. Display
7. RS-232
8. USB
9. Terminal power supply unit
10. Battery compartment
11. Transportation locks
12. Adjustment switch



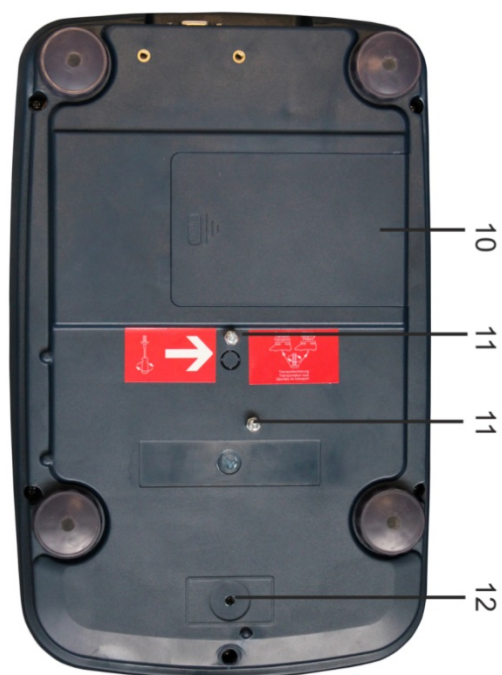



Example EWJ 300-3H:

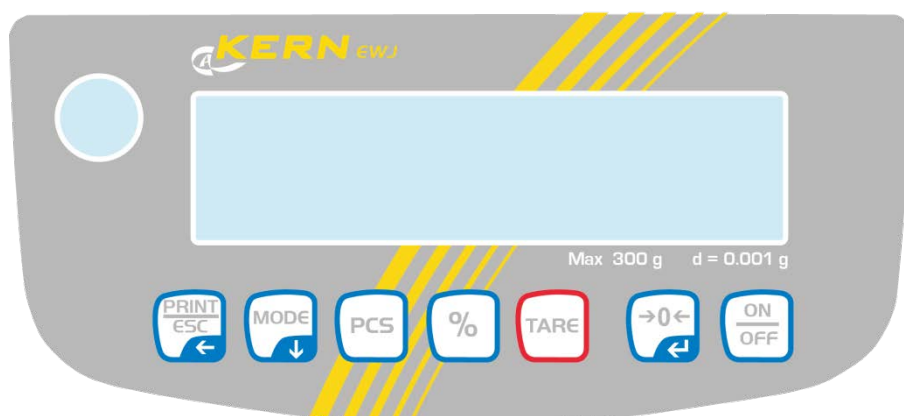

- 13. Windshield
- 14. Weighing pan
- 15. Display
- 16. Bubble level
- 17. Keyboard
- 18. Levelling screw
- 19. RS-232
- 20. USB
- 21. Terminal power supply unit
- 22. Battery compartment
- 23. Transportation locks
- 24. Adjustment switch

2.1 Keyboard overview



Key	Function	Function in Menu
	Calculate weighing data via interface	Exit menu / back to weighing mode.
	Switch-over weighing unit	Scroll forward in menu
	Parts counting Delete total added memory	
	Percent determination Start internal adjustment (longer pressing of the button)	
	Taring	
	Zeroing	Take over selected setting
	Turn on/off	

3 Basic Information (General)

3.1 Proper use

The balance you purchased is intended to determine the weighing value of material to be weighed. It is intended to be used as a “non-automatic balance”, i.e. the material to be weighed is manually and carefully placed in the centre of the weighing pan. As soon as a stable weighing value is reached the weighing value can be read.

3.2 Improper Use

Do not use balance for dynamic weighing. In the event that small quantities are removed or added to the material to be weighed, incorrect weighing results can be displayed due to the “stability compensation“. (Example: Slowly draining fluids from a container on the balance.)

Do not leave permanent load on the weighing pan. This may damage the measuring system.

Impacts and overloading exceeding the stated maximum load (max) of the balance, minus a possibly existing tare load, must be strictly avoided. Balance may be damaged by this.

Never operate balance in explosive environment. The serial version is not explosion protected.

The structure of the balance may not be modified. This may lead to incorrect weighing results, safety-related faults and destruction of the balance.

The balance may only be used according to the described conditions. Other areas of use must be released by KERN in writing.

3.3 Warranty

Warranty claims shall be voided in case

- Our conditions in the operation manual are ignored
- The appliance is used outside the described uses
- The appliance is modified or opened
- mechanical damage and damage caused by media, liquids, natural wear and tear
- The appliance is improperly set up or incorrectly electrically connected
- The measuring system is overloaded

3.4 Monitoring of Test Resources

In the framework of quality assurance the measuring-related properties of the balance and, if applicable, the testing weight, must be checked regularly. The responsible user must define a suitable interval as well as type and scope of this test. Information is available on KERN's home page (www.kern-sohn.com) with regard to the monitoring of balance test substances and the test weights required for this. In KERN's accredited DKD calibration laboratory test weights and balances may be calibrated (return to the national standard) fast and at moderate cost.

4 Basic Safety Precautions

4.1 Pay attention to the instructions in the Operation Manual



Carefully read this operation manual before setup and commissioning, even if you are already familiar with KERN balances.

All language versions contain a non-binding translation. The original German is binding.

4.2 Personnel training

The appliance may only be operated and maintained by trained personnel.

5 Transport and storage

5.1 Testing upon acceptance

When receiving the appliance, please check packaging immediately, and the appliance itself when unpacking for possible visible damage.

5.2 Packaging / return transport



- ⇒ Keep all parts of the original packaging for a possibly required return.
- ⇒ Only use original packaging for returning.
- ⇒ Prior to dispatch disconnect all cables and remove loose/mobile parts.
- ⇒ Reattach possibly supplied transport securing devices.
- ⇒ Secure all parts such as the glass wind screen, the weighing platform, power unit etc. against shifting and damage.

6 Unpacking, Setup and Commissioning

6.1 Installation Site, Location of Use

The balances are designed in a way that reliable weighing results are achieved in common conditions of use.

You will work accurately and fast, if you select the right location for your balance.

Therefore, observe the following for the installation site:

- Place the balance on a firm, level surface;
- Avoid **extreme heat as well as temperature fluctuation** caused by installing next to a radiator or in the direct sunlight;
- Protect the balance against direct draughts due to open windows and doors;
- Avoid jarring during weighing;
- Protect the balance against high humidity, vapours and dust;
- Do not expose the device to extreme dampness for longer periods of time. Non-permitted condensation (condensation of air humidity on the appliance) may occur if a cold appliance is taken to a considerably warmer environment. In this case, acclimatize the disconnected appliance for ca. 2 hours at room temperature.
- Avoid static charge of goods to be weighed or weighing container.

Major display deviations (incorrect weighing results) may be experienced should electromagnetic fields (e.g. due to mobile phones or radio equipment), static electricity accumulations or instable power supply occur. Change location or remove source of interference.

6.2 Unpacking, Scope of delivery

Remove device and accessories carefully from packaging, remove packaging material and place device at the planned work place. Verify that there has been no damage and that all packing items are present.

6.2.1 Scope of delivery / serial accessories:

- Balance, see chap. 2
- Mains adapter
- Protective cover
- Operating manual
- Transport Securing
- Glass wind shield only models EWJ 300-3, EWJ 300-3H, EWJ 600-2M

6.2.2 Installing / removing transport fittings

The right place is decisive for the accuracy of the weighing results of high-resolution precision balances (see chap. 6.1).

- ⇒ Removing transport locking devices

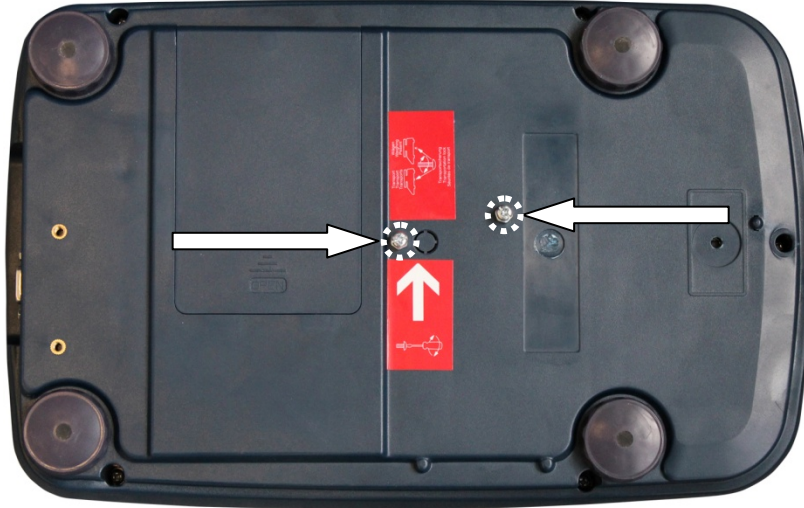

- ⇒ Install weighing plate and wind shield if necessary.
- ⇒ Level balance with foot screws until the air bubble of the water balance is in the prescribed circle.

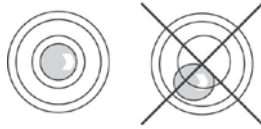

- ⇒ Check levelling regularly

6.3 Mains connection

Power is supplied via the external mains adapter. The stated voltage value must be the same as the local voltage.

Only use KERN original mains adapter. Using other makes requires consent by KERN.

6.4 Storage battery operation (optional)

Before the first use, the battery should be charged by connecting it to the mains power supply for at least 12 hours.

The LED display provides information about the battery's charging status.



Voltage has dropped below prescribed minimum.



Rechargeable battery very low.



Rechargeable battery completely reloaded

To spare the rechargeable battery the permanent background illumination of the display can be switched off in the menu item „F2 bl“, see chapter 8.2.

6.5 Connection of peripheral devices

Before connecting or disconnecting of additional devices (printer, PC) to the data interface, always disconnect the balance from the power supply.

With your balance, only use accessories and peripheral devices by KERN, as they are ideally tuned to your balance.

6.6 Initial Commissioning

In order to obtain exact results with the electronic balances, your balance must have reached the operating temperature (see warming up time chap. 1). During this warming up time the balance must be connected to the power supply (mains, accumulator or battery).

The accuracy of the balance depends on the local acceleration of gravity.

Strictly observe hints in chapter Adjustment.

6.7 Adjustment

As the acceleration value due to gravity is not the same at every location on earth, each display unit with connected weighing plate must be coordinated - in compliance with the underlying physical weighing principle - to the existing acceleration due to gravity at its place of location (only if the weighing system has not already been adjusted to the location in the factory). This adjustment process must be carried out for the first commissioning, after each change of location as well as in case of fluctuating environment temperature. To receive accurate measuring values it is also recommended to adjust the display unit periodically in weighing operation.



- Observe stable environmental conditions. Stabilisation requires a certain warm-up time.

6.7.1 Manual internal adjustment by pressing button

⇒ In weighing mode keep  pressed as long as „CAL“ is displayed

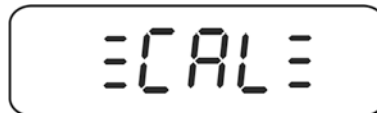

⇒ The motor noise of the loading system for the internal adjustment weight can be heard, the internal adjustment is started.
After successful adjustment „PASS“ will be displayed. The balance returns automatically into weighing mode.

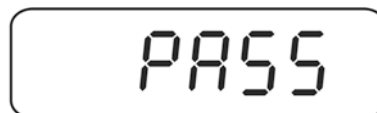

6.7.2 Automatic internal adjustment

Automatic adjustment takes place:

- when the balance is switched off and on.
- at the end of a time interval

After a set time interval (selectable 1 – 8 hrs.) in the menu (**F5 HoUr**, see chap. 8.3) the internal adjustment is automatically started.

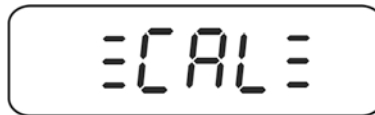

⇒ The motor noise of the loading system for the internal adjustment weight can be heard, the internal adjustment is started.

After successful adjustment „PASS“ will be displayed. The balance returns automatically into weighing mode.

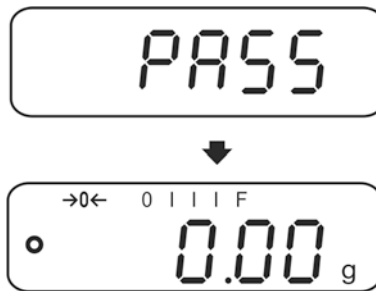

6.8 Verification

General introduction:

According to EU directive 90/384/EEC or 2009/23EG balances must be officially verified if they are used as follows (legally controlled area):

- a) For commercial transactions if the price of goods is determined by weighing.
- b) For the production of medicines in pharmacies as well as for analyses in the medical and pharmaceutical laboratory.
- c) For official purposes
- d) For manufacturing final packages

In cases of doubt, please contact your local trade in standard.

Verification notes:

An EU type approval exists for balances described in their technical data as verifiable. If a balance is used where obligation to verify exists as described above, it must be verified and re-verified at regular intervals.

Re-verification of a balance is carried out according to the respective national regulations. The validity for verification of balances in Germany is e.g. 2 years.

The legal regulation of the country where the balance is used must be observed!



Verification of the balance is invalid without the seal.

The seal marks attached on balances with type approval point out that the balance may only be opened and serviced by trained and authorised specialist staff. If the seal mark is destroyed, verification loses its validity. Please observe all national laws and legal regulations. In Germany a re-verification will be necessary.

Position of seals and adjusting switch:

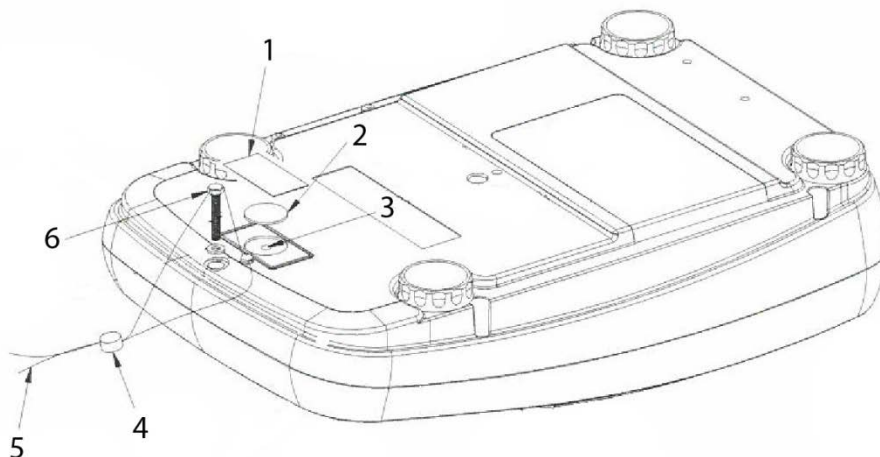

1. Self-destroying seal mark
2. Plastic disk to cover the adjustment switch
3. Adjustment switch
4. Lead
5. Wire
6. Housing screw

7 Operation

7.1 Start-up

⇒ Press .

The display is shining and the motor noise of the loading system for the internal adjustment weight can be heard.

The balance carries out a selftest, the maximum load and software version will also be shortly displayed, followed by the internal adjustment. During this process „CAL“ appears in the display.

As soon as the weight display appears, the balance is ready for weighing.



7.2 Switching Off

⇒ Press , the display will disappear.

7.3 Zeroing

Resetting to zero corrects the influence of light soiling on the weighing plate.

⇒ Unload the balance

⇒ Press  and zero display as well as indicator →0← will appear.



7.4 Simple weighing

⇒ Place goods to be weighed on balance.

⇒ Wait for stability display .

⇒ Read weighing result.



Overload warning

Overloading exceeding the stated maximum load (max) of the device, minus a possibly existing tare load, must be strictly avoided. This could damage the instrument.

Exceeding maximum load is indicated by the display of „----“ and an audio sound. Unload weighing system or reduce preload.

7.5 Weighing with tare

⇒ Deposit empty weighing container. Wait for stability display, then press . Zero display appears. The weight of the container is now internally saved.

⇒ Weigh the material, the net weight will be indicated.



- The balance is able to only store one taring value at a time.
- When the balance is unloaded the saved taring value is displayed with negative sign.
- To delete the stored tare value remove load from the weighing plate and press .
- The taring process can be repeated any number of times, e.g. when adding several components for a mixture (adding). The limit is reached when the taring range capacity is full.

7.6 Percent determination

Percent weighing allows to display weight in percent, in relation to a reference weight.

Put the nominal weight

⇒ Place the nominal weight (reference weight which corresponds to 100 %).

⇒ Wait for stability display, then press . 100% is displayed.

Percent weighing /commutation

⇒ Place goods to be weighed on balance.

The weight of the item to be weighed is displayed in percent, with reference to the nominal weight.

⇒ Press , the weight of the item to be weighed is displayed in the current weighing unit e.g. gram.

7.7 Parts counting

Before the balance can count parts, it must know the average part weight (i.e. reference). Proceed by putting on a certain number of the parts to be counted. The balance determines the total weight and divides it by the number of parts, the so-called reference quantity. Counting is then carried out on the basis of the calculated average piece weight.

As a rule:

The higher the reference quantity the higher the counting exactness.

Set reference

- ⇒ Press , the current reference quantity (e.g. 10) and the indicator **Pcs** are displayed.



- ⇒ Use  to set the desired reference quantity (e.g. 100), selectable SP 10, SP 20, SP 50, SP100, SP 200.



- ⇒ Place as many items to be counted (such as 100 items) as demanded by the set reference quantity and confirm by . The weighing scales calculate the reference weight. The current quantity (such as 100 items) will be displayed.



- ⇒ Remove reference weight. The balance is from now in parts counting mode counting all units on the weighing plate.

Switching over between quantity and weight display

- ⇒ Place load on pan and read the number of pieces.
- ⇒ Press , the weight will be displayed.

7.8 Manual totalizing

With this function the individual weighing values are added into the summation memory by pressing  and edited, when an optional printer is connected.



The totalizing function is only available at menu setting „SALE-Mode no“, see chap. 8.2.



- For menu settings, see chapter 8.2:
„F3 COM“ ⇒ „S 232“ ⇒ „P Prt“
„SALE n“
- The totalizing function is not active when the weight is under 20d.

Add up:

⇒ Place item to be weighed A, e.g. 100 g.

Wait for stability display, then press . The weight value will be saved and printed if an optional printer is connected. The number of weighings, followed by the total weight will be indicated.



⇒ Remove the weighed good. More weighed goods can only be added when the display \leq zero.



⇒

⇒ Place item to be weighed B, e.g. 200 g.

Wait for stability display, then press . The weight value will be added to the summation memory and edited. Number of weighings, followed by the total weight will be displayed for 2 sec. After that the current weighing value is displayed.



⇒ Add more weighed goods as described before.

Please note that the weighing system must be unloaded between the individual weighing procedures.

This process may be repeated 99 times or till such time as the capacity of the weighing system has been exhausted.

Display and output sum „Total“:

- ⇒ When the balance is **unloaded** (zero display) press , the number of weighings, followed by the total weight will be shown for 2 sec and printed if an optional printer is connected.

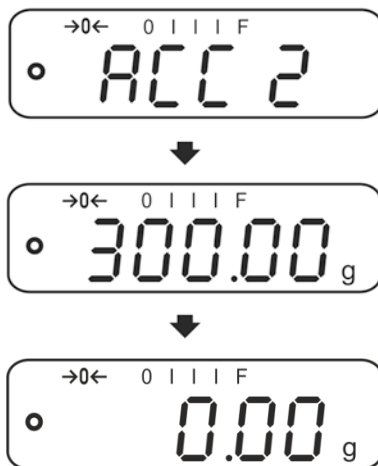

Delete total added memory:

- ⇒ When display „**Sum „Total“**“ appears, press . The data in the summation memory are deleted.

Printout example (KERN YKB-01N):

1:	100.00 g	First weighing
G:	100.00 g	
2:	200.00 g	Second weighing
G:	200.00 g	
1-2:	300.00 g	Total of weighing processes 1 - 2

7.9 Automatic adding-up

With this function the individual weighing values are automatically added into the summation memory when the balance is unloaded without pressing  and edited, when an optional printer is connected.



The totalizing function is only available at menu setting „SALE-Mode no“, see chap. 8.2.



- Menu settings, chap. 8.2:
„F3 COM“ ⇒ „S 232“ ⇒ „P AUto“
„SALE n“
- The totalizing function is not active when the weight is under 20d.

Add up:

- ⇒ Place item to be weighed A, e.g. 100 g.
After stabilisation control has taken place, you will hear an audio sound.



- ⇒ Remove the weighed good. The weighing value is added to the summation memory and printed if an optional printer is connected.



- ⇒ More weighed goods can only be added when the display \leq zero.
⇒ Place item to be weighed B, e.g. 200 g.
After stabilisation control has taken place, you will hear an audio sound.



- ⇒ Remove the weighed good. The weighing value is added to the summation memory and printed if an optional printer is connected. Number of weighings, followed by the total weight will be displayed for 2 sec.

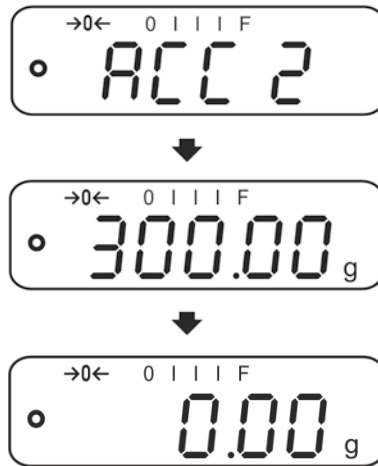

- ⇒ Add more weighed goods as described before.
Please note that the weighing system must be unloaded between the individual weighing procedures.







This process may be repeated 99 times or till such time as the capacity of the weighing system has been exhausted.



Display and delete the weighing data, as well as printout examples see chap. 7.9.

8 Menu

8.1 Navigation in the menu

Call up menu	⇒ Switch-on balance and during the selftest press  . The first menu item „F1 Unt,, is displayed.
Select menu item	⇒ With help of  , the individual menu items can be selected one after the other.
Select setting	⇒ Confirm selected menu item by pressing  . The current setting will be displayed.
Change settings	⇒ Switch into the available settings using  .
Acknowledge setting / exit the menu	⇒ Either save by pressing  or cancel by pressing  .
Return to weighing mode	⇒ Press  repeatedly to exit menu.

8.2 Access to technology menu

The access to the technology menu „tECH“ is locked by the key combination



When on balances with type approval „tECH“ is displayed, the seal mark must be destroyed and the adjustment switch be actuated. Position of adjustment switch see chap. 6.11

Attention:



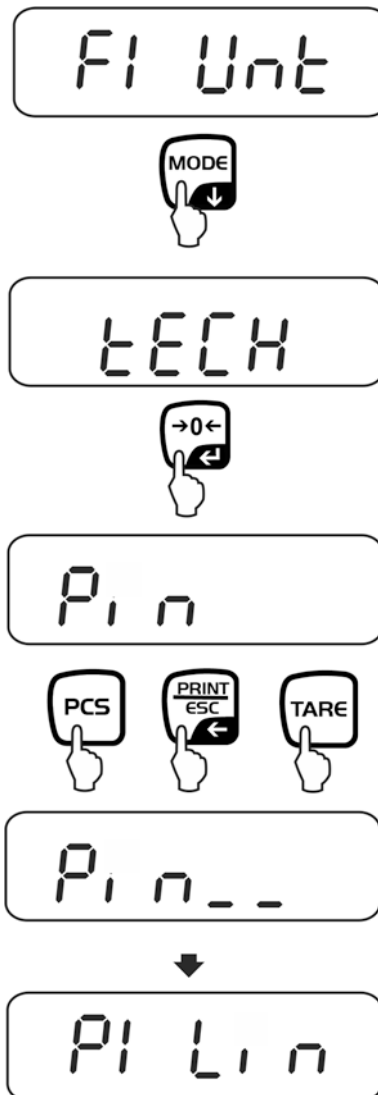

After destruction of the seal the balance must be re-verified by an authorised agency and a new verification wire/seal mark fitted before it can be reused for applications subject to verification.







8.3 Overview



Factory settings are marked by *.

Menu block	Menu item	Available settings / explanation	
F1 Unt Weighing Units		Not documented	
F2 bl Display background illumination	EL AU*	Automatic background illumination on when weighing pate is loaded or key pressed.	
	EL on	Background lighting of display is switched on permanently	
	EO oFF	Display background illumination off	
F3 Com Interface parameter	S 232	Use  to select interface: RS232 or USB	
	S USB	P Prt*	<ul style="list-style-type: none"> Output of a stable weighing value after pressing of  (menu setting „F4 ACC oFF“) Manual totalizing (menu setting „F4 ACC on“, see chap. 7.9. <p>Press  and the weighing value will be added to the summation memory and issued.</p>
		P Cont	Continuous data output see chap. 9.3
	P AUto	For automatic add-up see chap. 7.10. This function is used to issue and add individual weighing values automatically to the summation memory on unloading of weighing scale.	
	wirel	Not documented	
	P ASK	Remote control instructions	
		Command	Function
		S	Stable weighing value for the weight is sent via the interface
		W	Weighing value for the weight (stable or unstable) is sent via the interface
		T	No data are sent, the balance carries out the tare function.
		Z	No data are sent, the zero-display appears.
	P	Quantity will be sent via the interface	
	Acknowledge selection by  .		
b600 ↓ b 9600*	Baud rate 600, 1200, 2400, 4800, 9600 selectable.		
Acknowledge selection by  .			

		tP	Standard printer setting		
		LP 50	Not documented		
		Acknowledge selection by  .			
		Eng*	Standard setting English. only displayed for setting „LP 50“		
		chi	Not documented		
F4 SPD Display speed	SPd L	Verifiable models: “Low”	Non-verifiable models: SPd 1		
	SPd n	“Normal”	SPd 2		
	SPd H	“High”	SPd 3		
			SPd 4		
F5 HoUr	oFF	Automatic adjustment switched off			
	1 HoUr ↓ 8 HoUr	Time interval after which the automatic adjustment starts, selectable 1, 2, 3,4, 5, 6, 7, 8 hours.			
P6 bAtt	bAttoF	Mask loading status display „Recharg.battery“			
	bAtton	Display loading status display „Recharg.battery“			
SALE m	SALE n	Sale mode no: d= 0.1g			
		EWJ 300-3: d= 0.001 g	EWJ 600-2M: d= 0.01 g	EWJ 6000-1M: d= 0.1 g	
		Sale mode yes: d= 0.01 g			
	SALE y	EWJ 300-3: d= 0.01 g	EWJ 600-2M: d= 0.1 g	EWJ 6000-1M: d= 1 g	
<p>i The SALE mode is locked for balances with type approval. To disable the access lock, destroy the seal and actuate the adjustment switch. Position of the adjustment switch see chap. 6.11 Attention: After destruction of the seal the balance must be re-verified by an authorised agency and a new verification wire/seal mark fitted before it can be reused for applications subject to verification.</p>					

 <p>tECH Pin</p>	<p>Technology menu, see chap. 8.2</p> <p>At „Pin“ display press , ,  subsequently the first menu block „P1 Lin“ will be displayed.</p>	
P1 Lin	Linearisation (not documented)	
P2 CAL	Adjustment (not documented)	
P3 Cnt	XXXXX X	Display internal resolution
P4 A 2n	A2 oFF	Automatic zero point correction switched off
	A2n 0.5d	Automatic zero point correction (Autozero) by changing the display, digits selectable (0.5d, 1d, 2d, 4d)
	A2n 1d	
	A2n 2d* A2n 4d	
P5 GrA	XXXXX X	Local gravitational constant (not documented)
P6 CAP	XXXX	Capacity (max)

9 Interfaces



Via the interfaces weighing data may be exchanged with connected peripheral devices.

RS 232 interface	USB interface for PC connection
For menu settings, see chapter 8.2: „F3 COM“ ⇔ „S 232“	For menu settings, see chapter 8.2: „F3 COM“ ⇔ „USB“
Suitable peripheral devices: <ul style="list-style-type: none"> • Printer • PC 	Suitable peripheral devices: <ul style="list-style-type: none"> • PC <p>On the PC a virtual COM-Port is installed, which is recognized and triggered by the PC software (e.g. KERN balance connection).</p>
<p>i We recommend the USB interface set KERN DBS A02 (scope of supply: USB cable, driver CD, software balance connection.) For further information please go to KERN-Homepage (www.kern-sohn.com).</p>	

The following conditions must be met to provide successful communication between the weighing balance and the peripheral devices.

- Connect balance using a suitable cable with the interface of the peripheral device. Faultless operation requires an adequate KERN interface cable.
 - Communication parameters (baud rate, bits and parity) of balance and peripheral device must match.

9.1 Technical data

Connection (RS 232) 9 pin d-subminiature bushing

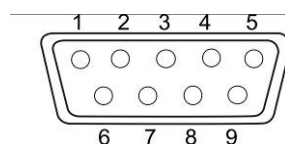

Pin 2 input

Pin 3 output

Pin 5 signal earth

Baud rate Optional 600/1200/2400/4800/9600

Parity 8 bits, no parity

9.2 Printer operation (RS 232)

Printout examples (KERN YKB-01N):

1. Menu setting F3 COM „P Prt“

Gross weight

G	300.00g
---	---------

Net weight

N:	100.0g
----	--------

Percent determination

PERC:	50.01 %
-------	---------

Parts counting

PCS	20PCS
UW:	5.00027g
G	100g

Totalization

1:	49.99g
G	49.99g
1:	49.99g
G	49.99g
3:	149.99g
G	149.99g
1-3	299.97g

2. Menu setting F3 COM „P Cont“

stable / gross

ST,GS:	50.00g
--------	--------

stable / net

ST,NT:	50.0g
--------	-------

unstable / gross

UT,GS:	50.00g
--------	--------

unstable / net

UT,NT:	50.0g
--------	-------



Weighing values \leq zero are not edited via the interface.

9.3 Output log (continuous output)

		,		□/—									k	g		CR	LF
-HEADER1-		-HEADER2-		-WEIGHT-								-WEIGHT UNIT-					

HEADER1: ST = stable, US = instable

HEADER2: NT = net , GS = gross

10 Servicing, maintenance, disposal



Before any maintenance, cleaning and repair work disconnect the appliance from the operating voltage.

10.1 Clean

Please do not use aggressive cleaning agents (solvents or similar agents), but a cloth dampened with mild soap suds. Ensure that no liquid penetrates into the device.

Polish with a dry soft cloth.

Loose residue sample/powder can be removed carefully with a brush or manual vacuum cleaner.

Spilled weighing goods must be removed immediately.

10.2 Servicing, maintenance

⇒ The appliance may only be opened by trained service technicians who are authorized by KERN.

⇒ Before opening, disconnect from power supply.

10.3 Disposal

Disposal of packaging and appliance must be carried out by operator according to valid national or regional law of the location where the appliance is used.

11 Instant help

In case of an error in the program process, briefly turn off the balance and disconnect from power supply. The weighing process must then be restarted from the beginning.

Help:

Fault

Possible cause

The displayed weight does not glow.

- The balance is not switched on.
- The mains supply connection has been interrupted (mains cable not plugged in/faulty).
- Power supply interrupted.

The displayed weight is permanently changing

- Draught/air movement
- Table/floor vibrations
- Weighing pan has contact with other objects.
- Electromagnetic fields / static charging (choose different location/switch off interfering device if possible)

The weighing result is obviously incorrect

- The display of the balance is not at zero
- Adjustment is no longer correct.
- The balance is on an uneven surface.
- Great fluctuations in temperature.
- Warm-up time was ignored.
- Electromagnetic fields / static charging (choose different location/switch off interfering device if possible)

Should other error messages occur, switch balance off and then on again. If the error message remains inform manufacturer.

12 Declaration of conformity

KERN[®] **KERN & Sohn GmbH**
D-72322 Balingen-Frommern
Postfach 4052
E-Mail: info@kern-sohn.de

Tel: 0049-[0]7433- 9933-0
Fax: 0049-[0]7433-9933-149
Internet: www.kern-sohn.de

Declaration of conformity

EG-Konformitätserklärung
EC- Déclaration de conformité
EC-Dichiarazione di conformità
EC- Declaração de conformidade
EC-Deklaracja zgodności

EC-Declaration of -Conformity
EC-Declaración de Conformidad
EC-Conformiteitverklaring
EC- Prohlášení o shode
EC-Заявление о соответствии

D	Konformitäts- erklärung	Wir erklären hiermit, dass das Produkt, auf das sich diese Erklärung bezieht, mit den nachstehenden Normen übereinstimmt.
GB	Declaration of conformity	We hereby declare that the product to which this declaration refers conforms with the following standards.
CZ	Prohlášení o shode	Tímto prohlašujeme, že výrobek, kterého se toto prohlášení týká, je v souladu s níže uvedenými normami.
E	Declaración de conformidad	Manifetamos en la presente que el producto al que se refiere esta declaración está de acuerdo con las normas siguientes
F	Déclaration de conformité	Nous déclarons avec cela responsabilité que le produit, auquel se rapporte la présente déclaration, est conforme aux normes citées ci-après.
I	Dichiarazione di conformità	Dichiariamo con ciò che il prodotto al quale la presente dichiarazione si riferisce è conforme alle norme di seguito citate.
NL	Conformiteit- verklaring	Wij verklaren hiermede dat het product, waarop deze verklaring betrekking heeft, met de hierna vermelde normen overeenstemt.
P	Declaração de conformidade	Declaramos por meio da presente que o produto no qual se refere esta declaração, corresponde às normas seguintes.
PL	Deklaracja zgodności	Niniejszym oświadczamy, że produkt, którego niniejsze oświadczenie dotyczy, jest zgodny z poniższymi normami.
RUS	Заявление о соответствии	Мы заявляем, что продукт, к которому относится данная декларация, соответствует перечисленным ниже нормам.

Electronic Balance: KERN EWJ

EU Directive	Standards
2004/108/EC	EN 55022: 2010 EN 61000-3-3: 2008 EN 55024: 2010
2006/95/EC	EN 60950: 2006+A11:2009

Datum 23.12.2013
Date

Ort der Ausstellung 72336 Balingen
Place of issue

Signatur
Signature



Albert Sauter
KERN & Sohn GmbH
Geschäftsführer
Managing director

KERN & Sohn GmbH, Ziegelei 1, D-72336 Balingen, Tel. +49-[0]7433/9933-0
Fax +49-[0]7433/9933-149, E-Mail: info@kern-sohn.com, Internet: www.kern-sohn.com